

Varenummer: 20822866B  
 Beskrivelse: E+G Mini positioneringsbolt  
 u. hvilestilling, GN 822.8-6-10-B

## Mål

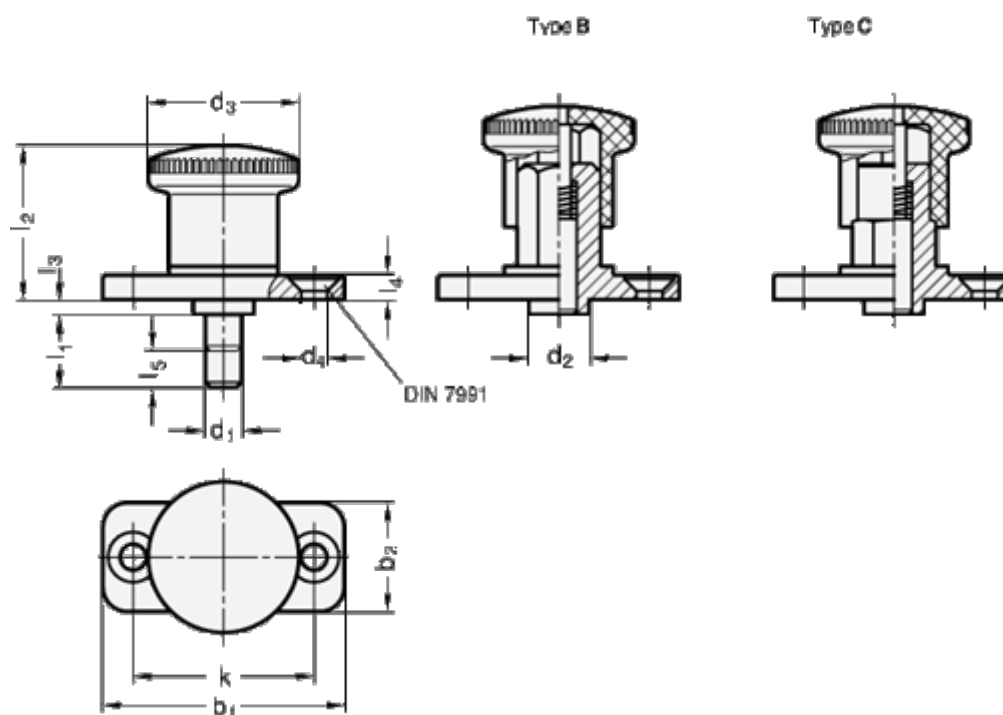

$b_1$	= 40	$l_1$ = 34.0
$b_2$	= 18	$l_2$ = 26
$d_1$	= 6	$l_3$ = 2.5
$d_2$	= 10	$l_4$ = 4
$d_3$	= 25	$l_5$ = 6
$d_4$	= 4.3	
Fjederkraft top N	= 6	
$k$	= 30	